





 coatcheck®

**onefive** ticketing system



user manual

# onefive ticketing system

-  CLOAKROOM, LUGGAGE TAG & ENTRY TICKETING SYSTEM
-  SYSTÈME D'ÉTIQUETAGE POUR VESTIAIRES, BAGAGES ET TICKETS
-  GARDEROBEN, GEPÄCKAUFBEWAHRUNG & EINTRITTSKASSE TICKETSYSTEM
-  IMPRESORA Y SISTEMA DE CONTROL PARA GUARDARROPA, EQUIPAJE Y ENTRADAS
-  GARDEROBE, ENTREE & BAGAGELABEL KASSA TICKET SYSTEM

## BOX CONTENT



TICKET  
PRINTER



AC/DC  
ADAPTER



POWER  
CABLE



NETWORK  
CABLE



USE IN A DRY AND DUST-FREE ENVIRONMENT. KEEP AWAY FROM LIQUIDS.  
KEEP AWAY FROM CHILDREN. DO NOT OPEN THE TICKET PRINTER USING TOOLS.

UTILISER DANS UN ENVIRONNEMENT SEC ET SANS POUSSIÈRE. ÉLOIGNER  
DES LIQUIDES. GARDER LOIN DES ENFANTS. NE PAS OUVRIR L'IMPRIMANTE  
DE BILLETS EN UTILISANT DES OUTILS.



BITTE VERWENDEN IN EINEM TROCKENEN UND STAUBFREIEN UMGEBUNG.  
FERNHALTEN VON FLÜSSIGKEITEN. VON KINDERN FERNHALTEN.  
ÖFFNEN SIE DIE TICKETDRUCKER NICHT MIT WERKZEUGEN.

UTILIZAR EN UN AMBIENTE SECO Y LIBRE DE POLVO. MANTENER ALEJADO  
DE LÍQUIDOS. NO APROPIADO PARA NIÑOS. NO ABRIR LA IMPRESORA,  
UTILIZANDO HERRAMIENTAS.



GEbruik IN EEN DROGE EN STOFVRIJE OMGEVING. HOUD UIT DE BUURT  
VAN VLOEISTOFFEN. NIET GESCHIKT VOOR GEbruik DOOR KINDEREN.  
TICKETPRINTER NIET OPENEN MET GEREEDSCHAP.

## INDEX

- 4 - QUICK CONNECT
- 5 - QUICK LOAD
- 6 - NORMAL USE
- 7 - REPORTS

## COATCHECK SOFTWARE

- 8 - SETUP AND TICKET LAYOUT EDITING
- 10 - PRINTER SETUP
- 12 - OPTIONAL KEYPAD SETUP
- 14 - TICKET EXAMPLES

## KEYPAD

- 16 - OPTIONAL KEYPAD

## MANUAL SETUP

- 18 - BUTTONS
- 19 - ENTER MANUAL SETUP MODE
- 20 - SETUP EXAMPLE : TICKET SYMBOL
- 21 - SETTINGS OVERVIEW

## MAINTENANCE

- 23 - QUICK MAINTENANCE

# QUICK CONNECT

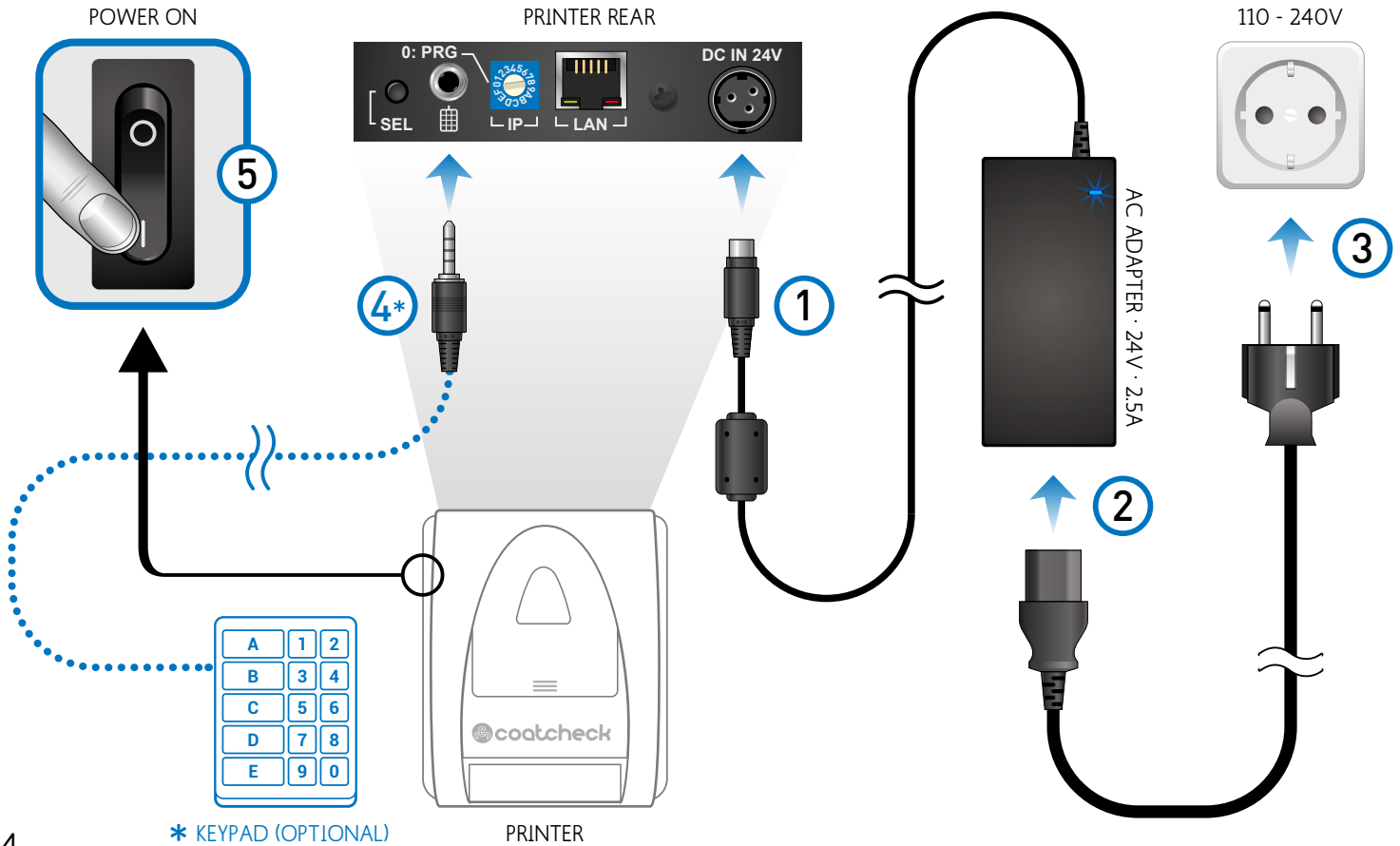

# QUICK LOAD

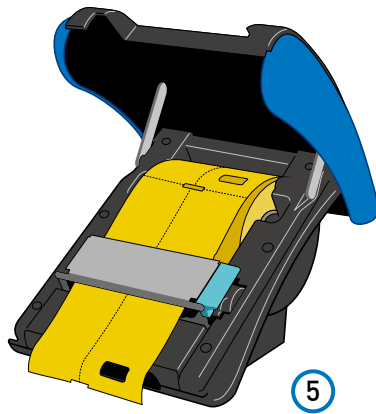
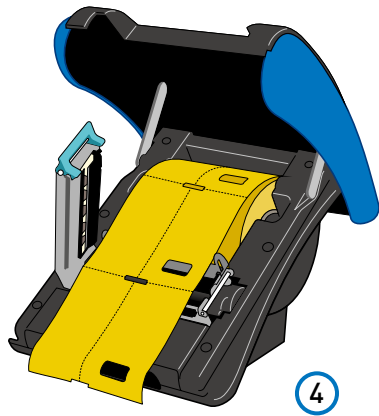
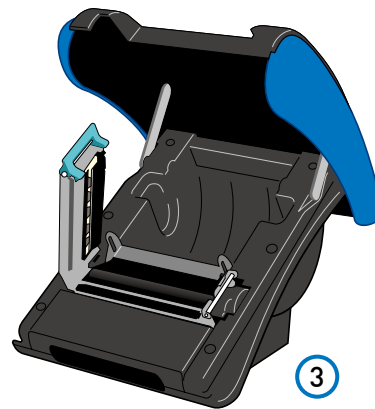

# NORMAL USE

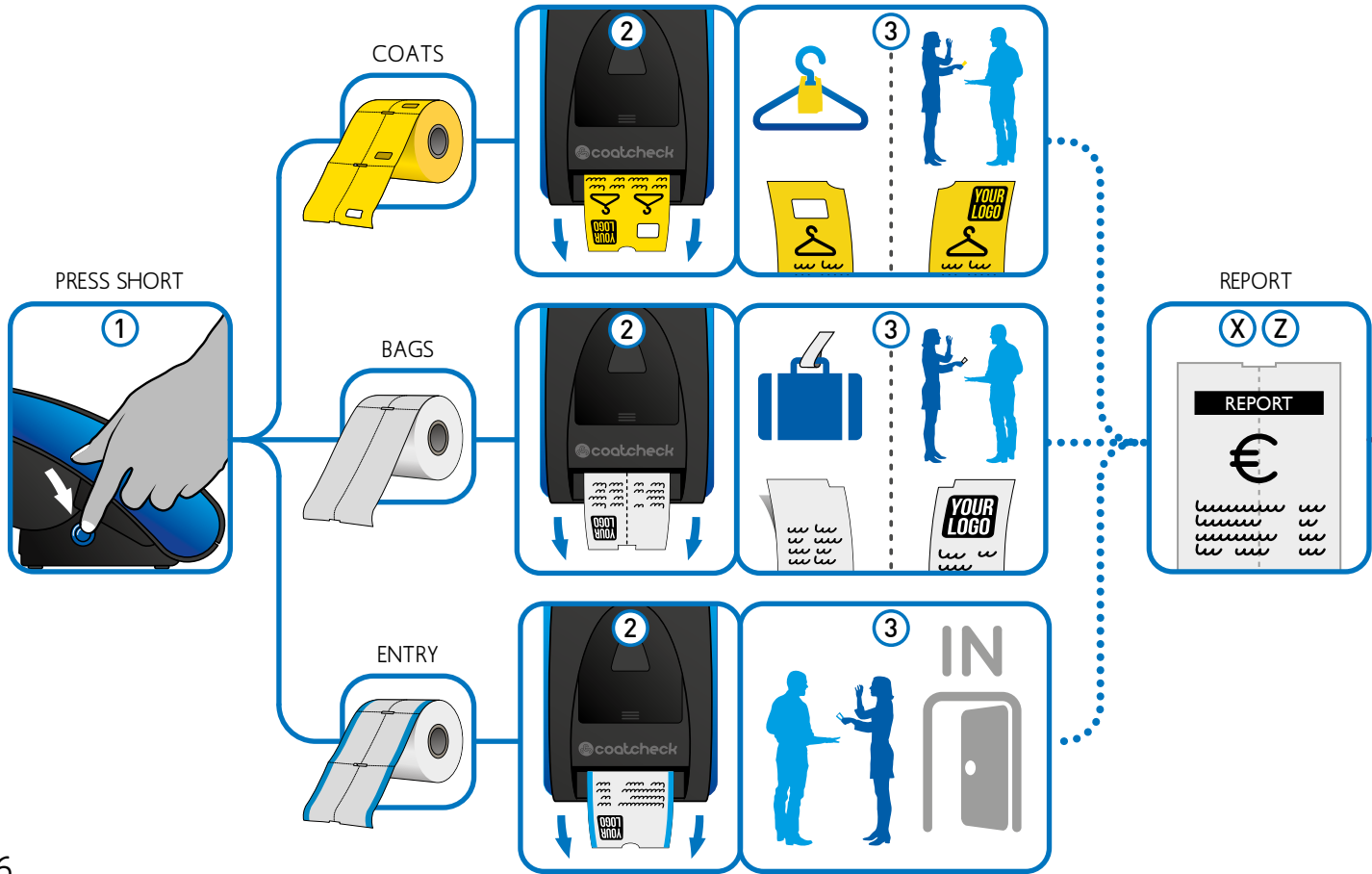

## TOTALS, NO RESET (X-REPORT & TICKET COUNT - EXAMPLE : END OF SHIFT)

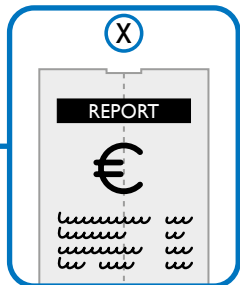

PRESS & HOLD



RELEASE AFTER 5 SEC.

## TOTALS & RESET (Z-REPORT & TOTAL TICKET COUNT - EXAMPLE : END OF EVENT)

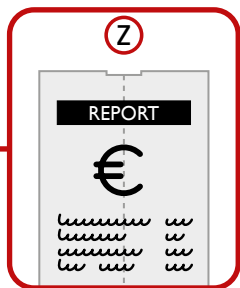

POWER OFF



PRESS & HOLD

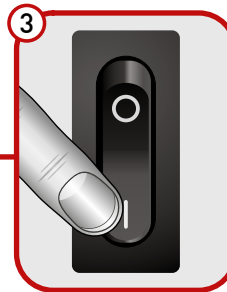

POWER ON



RELEASE AFTER 5 SEC.



AFTER PRINTING A Z-REPORT, THE COUNTER WILL RESET TO ZERO

## SETUP AND TICKET LAYOUT EDITING



- 1 DOWNLOAD AND INSTALL SOFTWARE  
Go to [www.cloakroom-solutions.com](http://www.cloakroom-solutions.com) and download and install the latest software.



PRINTER REAR



- 2 CONNECT PRINTER TO PC WITH PROVIDED NETWORK CABLE  
You can connect the printer via an optional network hub.

- 3 SWITCH **OFF** WiFi ON YOUR COMPUTER  
Also make sure your PC does not have access to any networks at this time.



\* NETWORK HUB (OPTIONAL)



WINDOWSTM PC





#### 4 START THE COATCHECK SOFTWARE

Once the software has started, click the CONNECT button. The CoatCheck software will now try to connect with the printer. The indicator will blink green / red. **During connection, your PC may not have access to the internet or other network sources.**

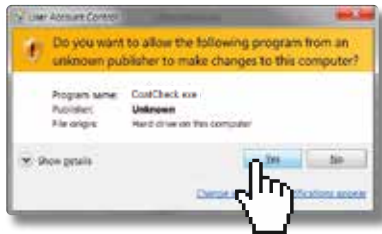

#### 5 GIVE THE SOFTWARE PERMISSION TO CONNECT TO THE PRINTER

Press YES when the dialogue appears.

#### 6 FIRST PRINT A Z-REPORT OR THE PRINTER WILL NOT ENTER SETUP MODE

You can print a Z-Report from the software. Press OK when the dialogue appears.



# COATCHECK SOFTWARE : PRINTER SETUP

1

2

12

13

19

4

5

6

7

8

9

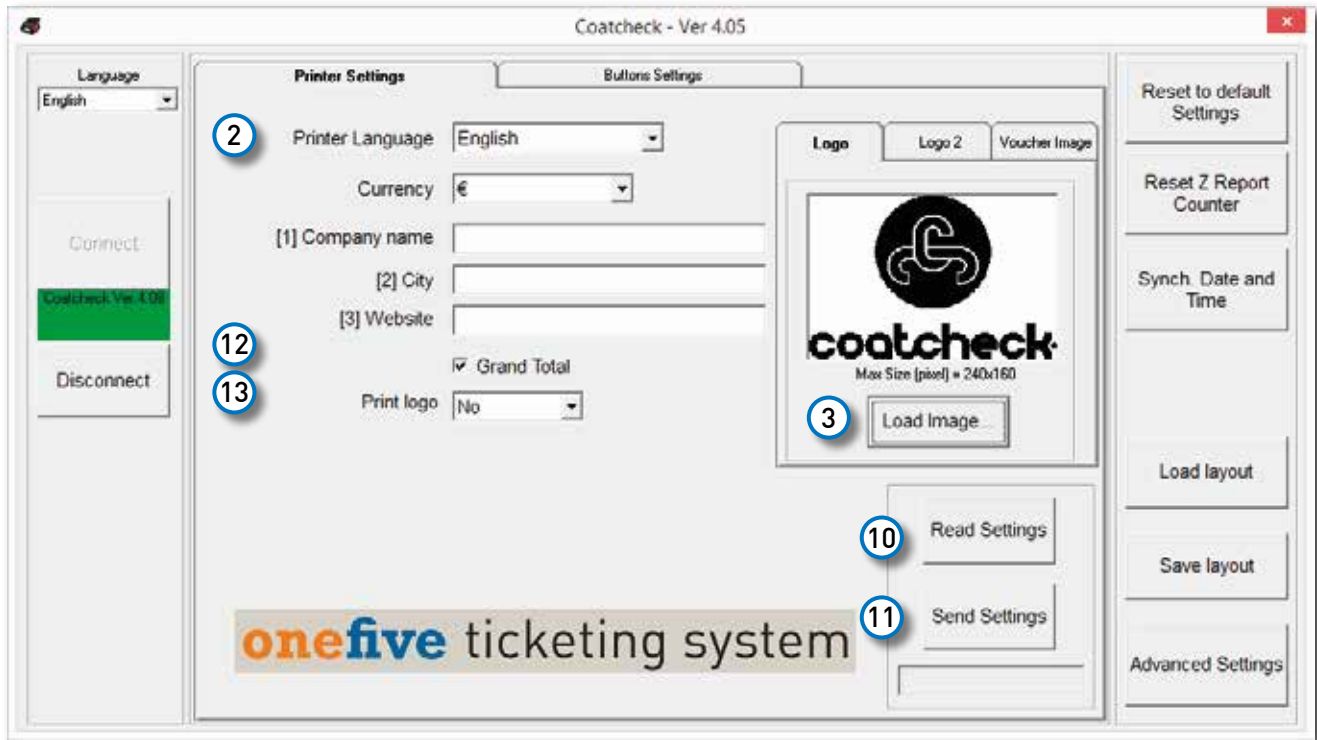

- ① Set SOFTWARE language : English / Nederlands / Deutsch / Français / Español
- ② Set PRINTER language : English / Nederlands / Deutsch / Français / Español  
Set currency : € / £ / \$ / empty (for other currencies)  
Set company name, city and website
- ③ Load your logo and voucher images. For the best results, use the exact pixel dimensions as specified (240 x 160 pixels for your logo and 576x390 pixels for the voucher) and use BMP files in *black & white only*. You can download examples from [www.cloakroom-solutions.com](http://www.cloakroom-solutions.com).
- ④ Reset to factory settings : restores all standard settings and cloakroom tickets A through E.
- ⑤ Reset Z-Report, Total counter and Grand Total. Password: one1five5
- ⑥ Synchronize date & time of the printer with your PC date & time.
- ⑦ Load an earlier saved layout file stored on your PC.
- ⑧ Save a layout file to your PC. This way you can keep your settings easily stored.
- ⑨ Advanced settings. This function is password protected and for use by agents only.
- ⑩ Read programmed settings from the printer memory to your PC.
- ⑪ Send programmed settings from your PC to the printer memory.
- ⑫ Print Grand Total on Z-Report? ON or OFF.
- ⑬ Print Logo or Company details on tickets? YES or NO.
- ⑰ **During programming and connection please DO NOT switch off the printer. After finishing, please use the DISCONNECT button and wait for a ticket to be printed. Your PC's network and internet connection settings (IP) will now have been restored.**

# COATCHECK SOFTWARE & OPTIONAL KEYPAD SETUP

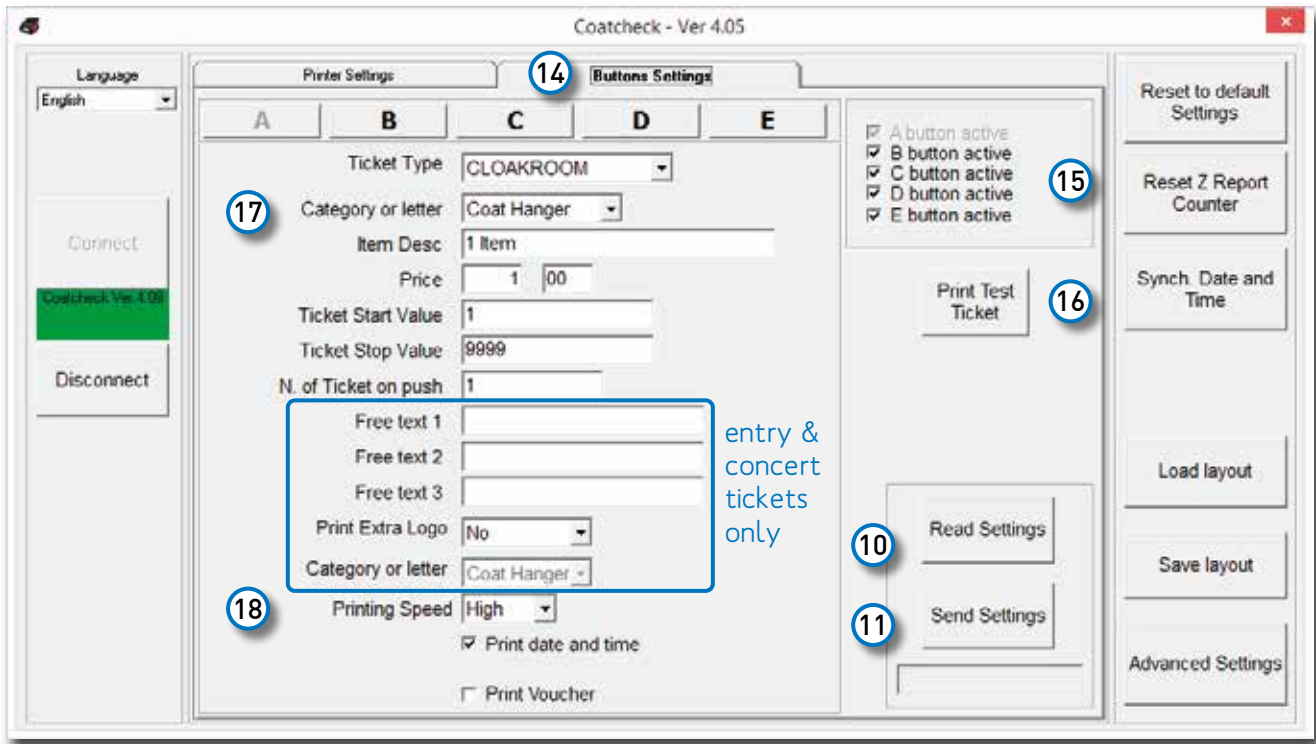

\* 14 15 These functions are only available when the optional external keypad was connected prior to starting the software.

- 14 Select keypad button A through E, for use with the optional external keypad.
- 15 Activate / deactivate keypad button B through E. Button A is always activated and will function the same as the PRINT button on the side of the printer.
- 16 Print a test ticket.
- 17 Set ticket type : CLOAKROOM / ENTRY (1-part) / CONCERT (2-part)  
 Category (symbol) or letter : Example :  / A / B / C / D / etc.  
 Item Description : Example : 1 item or 1 coat (only available for cloakroom tickets)  
 Price : the price of each ticket When the price is set to 0, no price will be printed on the ticket.  
 Ticket start value : Ticket numbering will start at this value.  
 Ticket stop value : Ticket numbering will stop at this value. Example : if this value is set to 100, the printer will print max. 100 tickets (venue / cloakroom capacity).  
 N. of tickets on push : Quantity of tickets printed every time the PRINT button is pressed.

Free text and extra logo are for ENTRY (1-part) and CONCERT (2-part) tickets only.

- 18 TICK OPTIONS
- |                           |  |
|---------------------------|--|
| Printing speed :          | Lowest speed gives higher quality. Highest speed is recommended as standard. |
| Date and time on tickets? | ON / OFF   |
| Ticket number on tickets? | ON / OFF   |
| Print a voucher ticket?   | ON / OFF : Prints a voucher image on a second ticket.                        |

- 19 **During programming and connection please DO NOT switch off the printer. After finishing, please use the DISCONNECT button and wait for a ticket to be printed. Your PC's network and internet connection settings (IP) will now have been restored.**

# TICKET EXAMPLES - CLOAKROOM & LUGGAGE TAG

CLOAKROOM

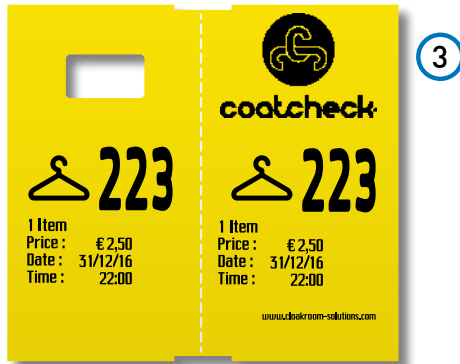

LUGGAGE TAG

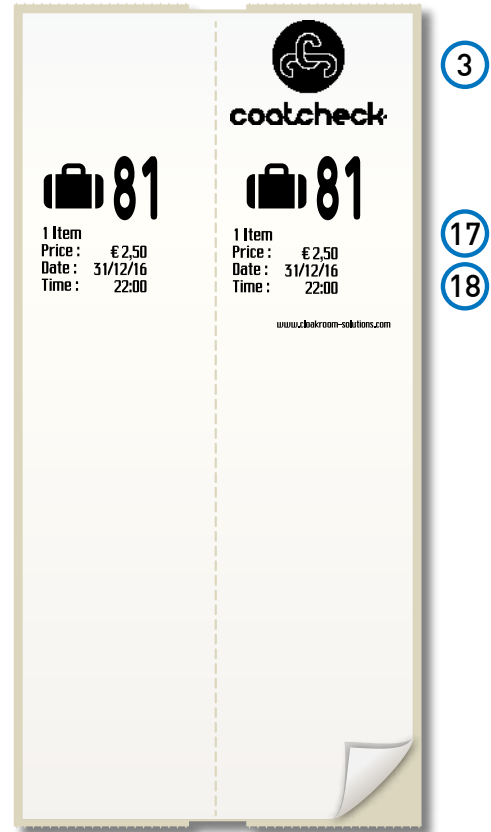

# TICKET EXAMPLES - ENTRY & CONCERT

## ENTRY

3



Your Company  
Your City  
yourwebsite.com

coatcheck

17

**This Saturday Night  
at your venue**  
yourwebsite.com

18

Price € 10,00 Code 9999  
Date 31/12/2016 Time 22:00

[www.zbookroom-solutions.com](http://www.zbookroom-solutions.com)

---

3



**FREE  
COFFEE**

ORIGINAL

## CONCERT



Your Company  
Your City  
yourwebsite.com

coatcheck

17

**This Saturday Night  
at your venue**  
yourwebsite.com

18

Price € 10,00 Code 9999  
Date 31/12/2016 Time 22:00

---



Price € 10,00 Code 9999  
Date 31/12/2016 Time 22:00

coatcheck [www.zbookroom-solutions.com](http://www.zbookroom-solutions.com)

- 18 Print extra voucher after ticket (ON / OFF) ; prints the voucher image on a second ticket

MORE FUNCTIONALITY  
WITH THE OPTIONAL

**onefive**

KEYPAD





## OPTIONAL KEYPAD

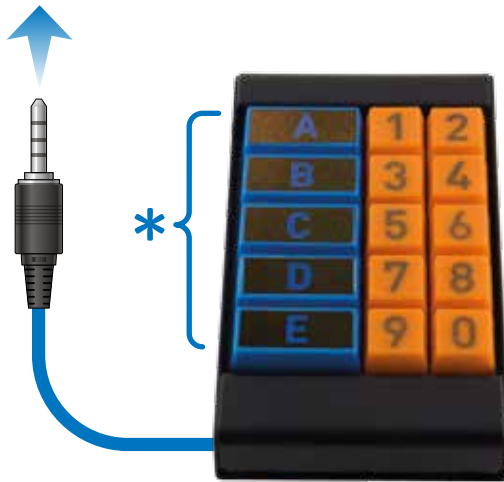
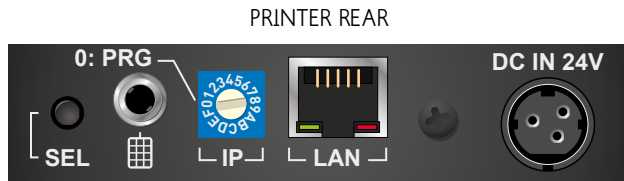

The optional keypad can be used to use multiple ticket settings. The A through E keys can each be programmed with the CoatCheck software (see page 12).

The number keys allow you to print any number of tickets. For instance : pressing 1, 0, B will result in 10 tickets with pre-programmed layout B to be printed.

If you press 0 first, you can reprint a number: Pressing 0, 1, 2, 5, A will result in another copy of ticket A125 being printed. Be careful in issuing double numbers.

- ① Switch printer OFF.
- ② Connect keypad as shown in diagram.
- ③ Switch printer ON.
- ④ Start the CoatCheck software.

Now the 5-button options will be available in the software.

You can program up to 5 ticket layouts. Key A is always active. This key has the same function as the print-button on the side of the printer.

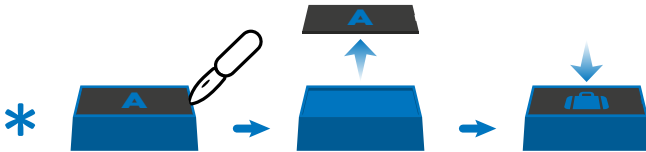

# MANUAL SETUP : BUTTONS

**PLEASE NOTE :** Manual setup is not easy and only recommended when you want to change simple settings and have no access to the CoatCheck software.

The following buttons / switches are used to enter the manual setup mode, select fields, change values and save settings.



SYMBOL	NAME	PRESS NORMAL	PRESS LONG
	PWR OFF	- turns the power off in all modes	
	PWR ON	- turns the power on in all modes - enters setup mode when used while PRINT & MODE are pressed	
	PRINT	- next field - next value	- reset field to default
	SEL	- enter	- save field

## MANUAL SETUP : ENTER SETUP MODE (NO NETWORK OR SOFTWARE)



1

turn power OFF

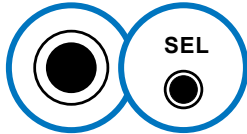

2

**press & hold** the  
PRINT and SEL  
buttons



3

**while holding**  
PRINT and SEL,  
turn power ON



4

release buttons  
when printer  
starts printing  
the setup menu



5











open the printer  
cover to see  
changes in the  
settings



**MAKE SURE YOU HAVE PRINTED A Z-REPORT FIRST OR THE PRINTER WILL NOT ENTER SETUP MODE. SEE PAGE 7 TO SEE HOW TO PRINT A Z-REPORT.**

## SETUP EXAMPLE : CHANGING THE TICKET SYMBOL

\* - first enter the setup mode as described on page 19

BUTTON	REPEATS	DESCRIPTION
	7x	- select the SYMBOL field  LANGUAGE    DATE    TIME    FIELD 1    FIELD 2    FIELD 3    ITEM NAME    SYMBOL
	1x	- enter EDIT mode for selected field (  : SYMBOL)
	1x	- change to next value (  to  )
	1x 5 SEC	- SAVE selected field (locks the new value  in field  )
		- turn power off to exit setup mode

# SETTINGS OVERVIEW

When entering setup mode and after every saved change, the printer will print a setup overview (as displayed below).

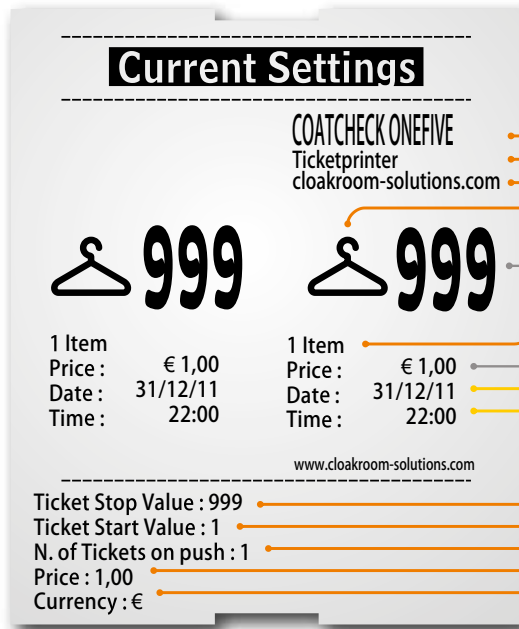

- |           |   |   |
|-----------|---|---|
| <b>A</b>  | LANGUAGE .....  | DEFAULT = English   |
| <b>1</b>  | FIELD 1 : COMPANY NAME .....  | DEFAULT = "COATCHECK ONEFIVE"   |
| <b>2</b>  | FIELD 2 : CITY .....  | DEFAULT = "Ticketprinter"   |
| <b>3</b>  | FIELD 3 : WEBSITE .....   | DEFAULT = "www.garderobe.nl"  |
| <b>5</b>  | CATEGORY OR LETTER .....  | DEFAULT =  |
|           | COUNTER   |   |
| <b>4</b>  | ITEM DESC. ....   | DEFAULT = 'ITEM'  |
|           | PRICE   |   |
| <b>B</b>  | DATE (DD/MM/YY)   |   |
| <b>C</b>  | TIME (HH:MM)  |   |
| <b>8</b>  | COUNTER ENDS AT ... ..  | DEFAULT = 999   |
| <b>7</b>  | COUNTER STARTS AT ... ..  | DEFAULT = 1   |
| <b>9</b>  | NUMBER OF TICKETS TO PRINT<br>EACH TIME THE PRINT BUTTON IS PRESSED | DEFAULT = 1   |
| <b>10</b> | PRICE PER ITEM .....  | DEFAULT = 1,00  |
| <b>6</b>  | CURRENCY SYMBOL .....   | DEFAULT = €   |



# Cloakroom, Luggage Tag & Entry Ticketing System

- CLOAKROOM, LUGGAGE TAG & ENTRY TICKETING SYSTEM
- SYSTEME D'ETIQUETAGE POUR VESTIERS, BAGAGES ET TICKETS
- GARDEROBES, SYSTEMES ALPHABETIQUES & ENDIGES TRACES TICKETING
- AMPIGNOLE E SISTEMA DE CODIFICAZIONE BAGAGLI, TICKETS E ENTRATE
- GARDEBOD, SYSTEME A BAGAGEL EN KASSA TICKET SYSTEM



**cloakcheck**

www.cloakroom-solutions.com

# QUICK MAINTENANCE

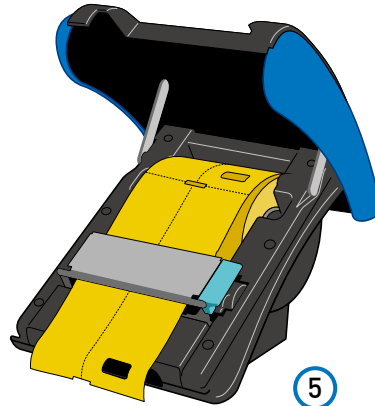
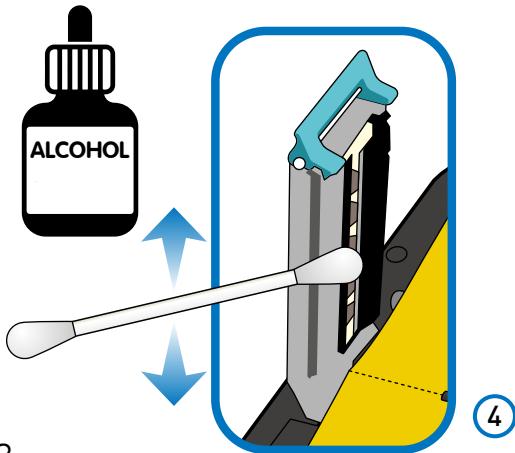
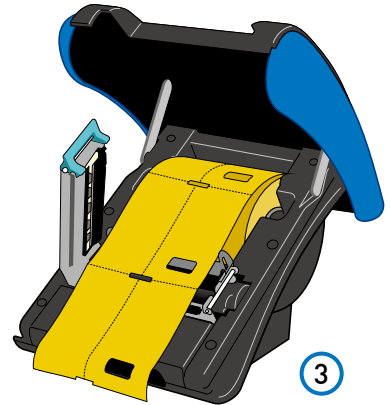
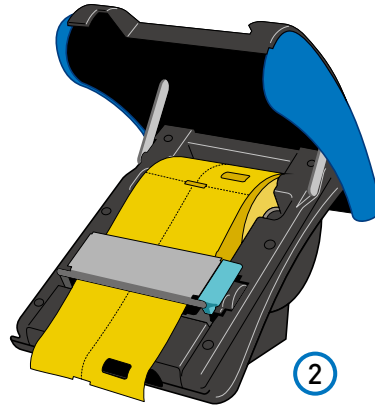



To download the latest software, order more tickets,  
subscribe to our newsletter or get support,  
visit the CoatCheck portal

[www.cloakroom-solutions.com](http://www.cloakroom-solutions.com)

